

BYD BATTERY-BOX PREMIUM QUICK START GUIDE

Valid for HVM-US HVM US 8.3, 11.0, 13.8, 16.6, 19.3, 22.1



Please note that this is a Quick Start Guide only, which is a shortened assistance for the installation of the BYD Battery-Box Premium HVM-US. It does not replace the Operating Manual, which must be read and understood completely before installation. Please download and view it on this website: www.bydbatterybox.com.

Attention: High Voltage! Improper handling can pose a risk of electric shock and damage.

This guide and procedures described herein are intended for use by skilled workers only.

A skilled worker is defined as a trained and qualified electrician or installer who has all of the following skills and experience:

- Knowledge of the functional principles and operation of on-grid systems.
- Knowledge of the dangers and risks associated with installing and using electrical devices and acceptable mitigation methods.
- Knowledge of the installation of electrical devices.
- Knowledge of and adherence to this guide, the complete installation manual and all safety precautions and best practices.

In order to ensure the normal operation of the BYD Battery System, please download the app Be Connect 2.0 and then finish the configuration in accordance with this document.

If there are errors generated during the commissioning or operation, please read the Service Guideline and Checklist alongside this document, or digital version on the website.

If the battery system doesn't start at all, please contact BYD's local after-sales service team within 48 hours. Otherwise, the battery could be permanently damaged.

Please do not stack up batteries without protective packages when storing or handling batteries, except for installation.

QR code for app.



Be Connect 2.0
Google Play



Be Connect 2.0
APP Store

1. Scope of Delivery

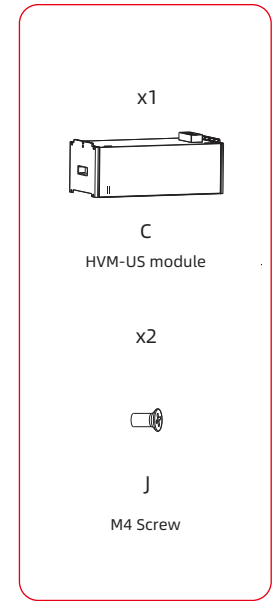
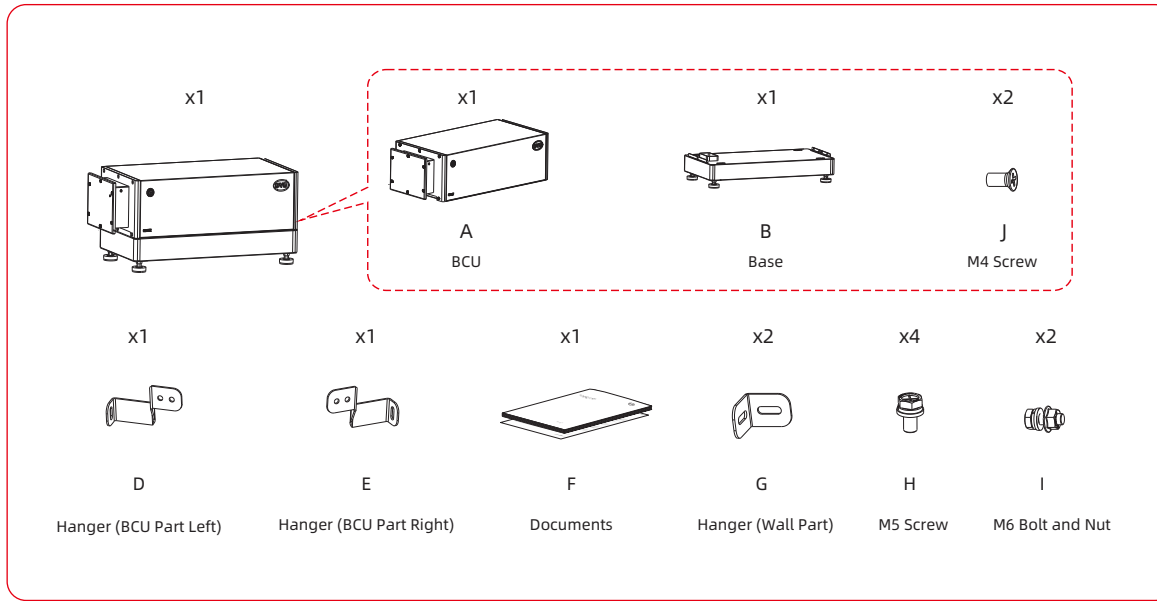

2. Not Included in Scope of Delivery

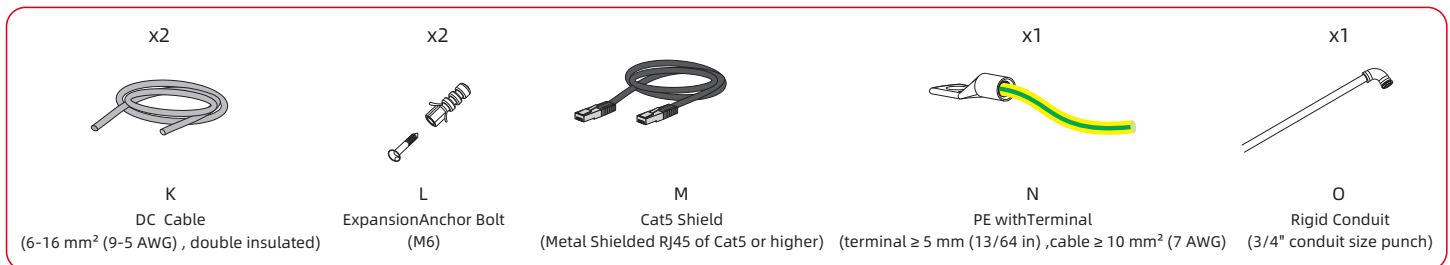

3. Tools

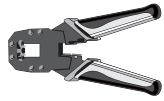

Network Wire Clamp



Pen



Phillips Screwdriver Bit

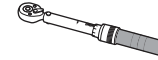

Torque Wrench



Flat-Head Screwdriver

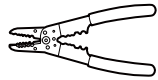

Wire Stripper



Cylinder Screwdriver



Wrench

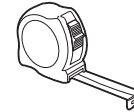

Tape Measure



Drill

4. Installation Location



Max +50 °C (122 °F)



Min -10 °C (14 °F)



RH. +5 %~+95 %

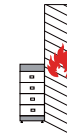

5. Module Parallel Connection Limitation

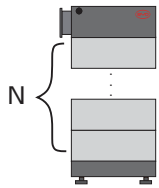

$3 \leq N \leq 8$ ✓



✗



✗

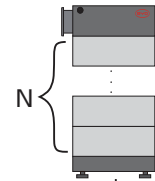
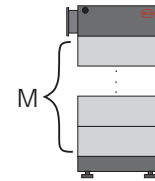
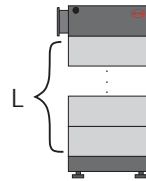

$L=M=N$ ✓

$L \neq M$ or $L \neq N$ or $M \neq N$ ✗

Max 3 towers in parallel

6. Installation

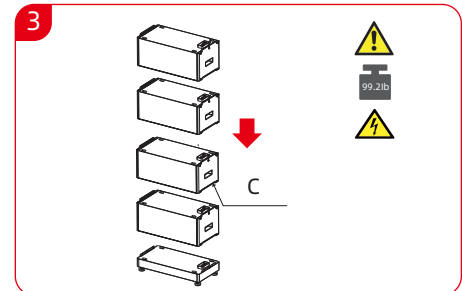
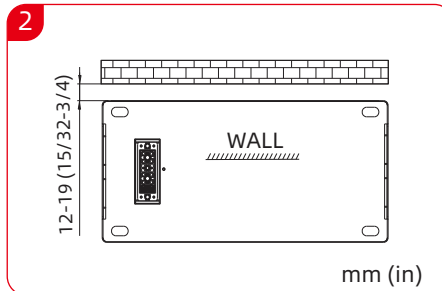
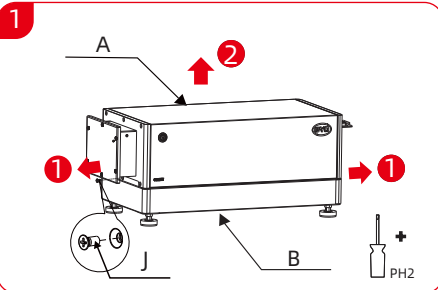

4

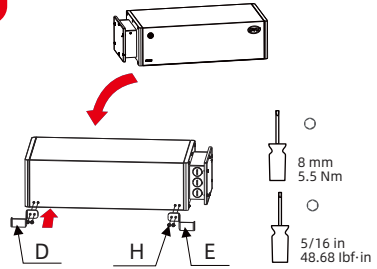

5

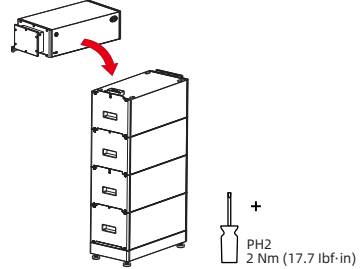

6

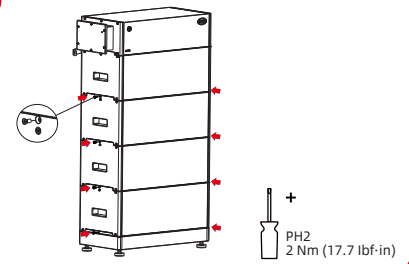

7

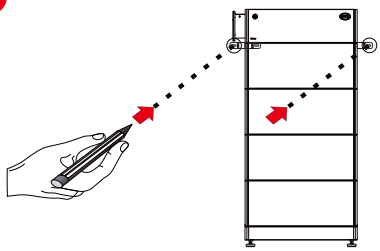

8

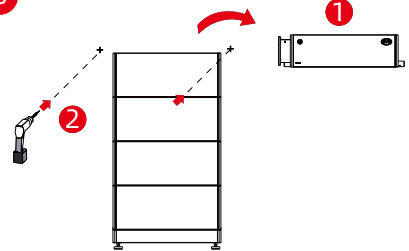

9

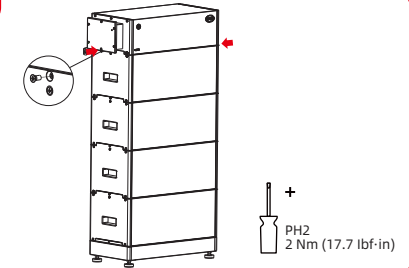

10

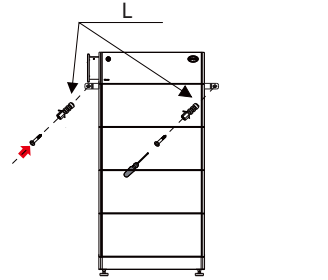

11

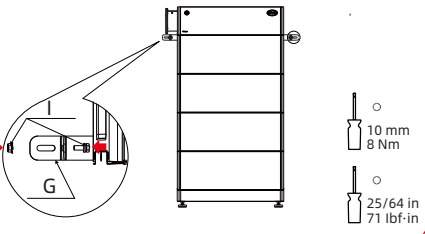

12

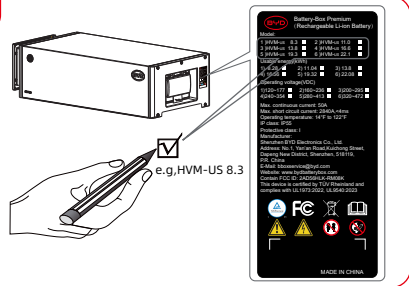

7. Connection Diagram

Single Tower

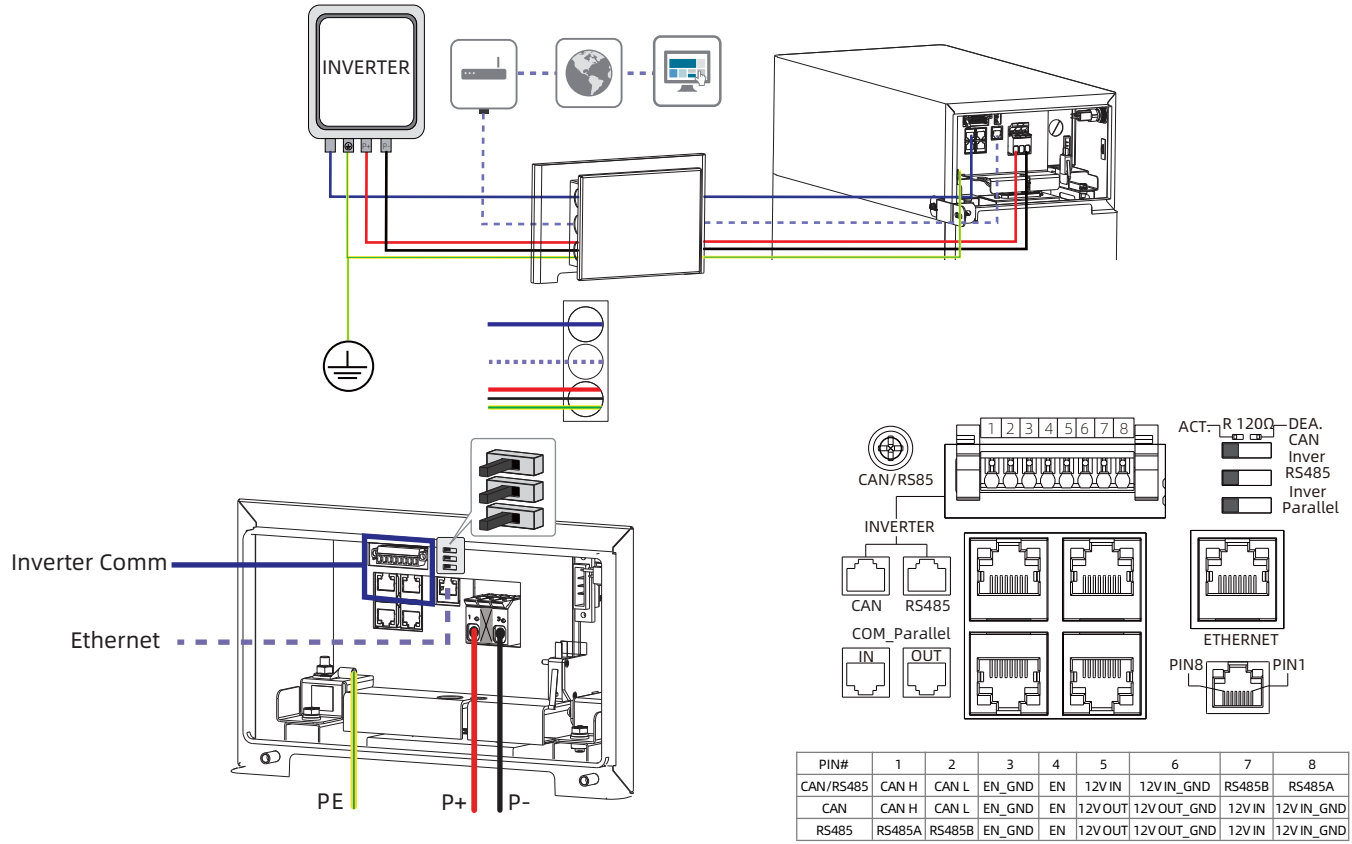

Three Towers. Ignore the Slave 1 in the drawing below to get the diagram of two towers.

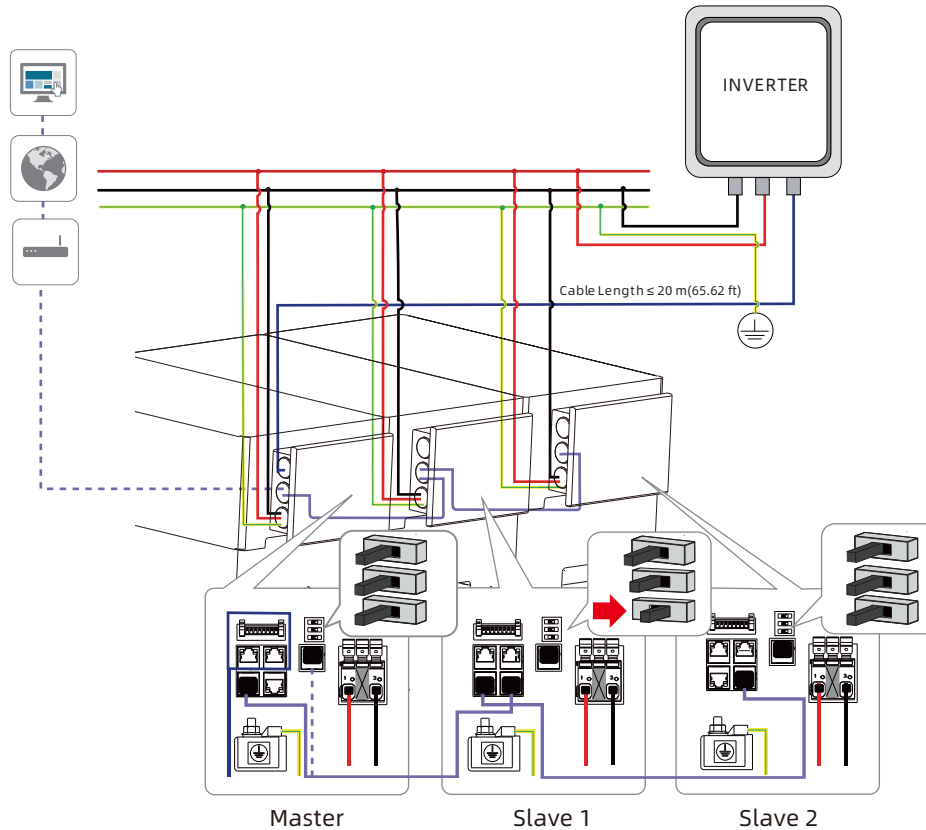

8. PE and DC Cables Connection

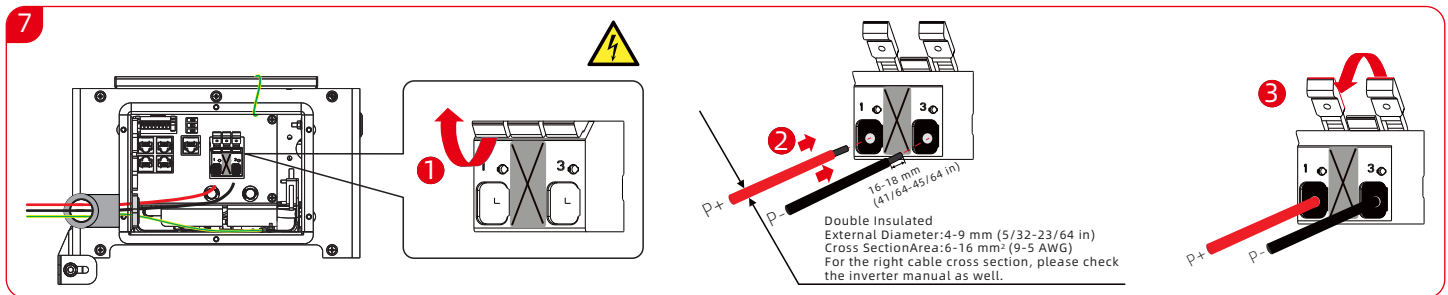
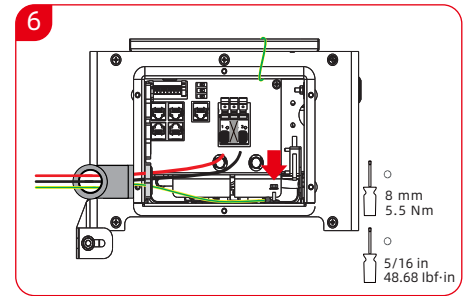
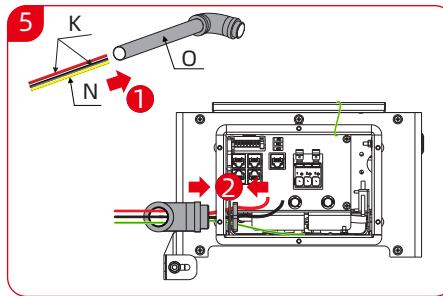
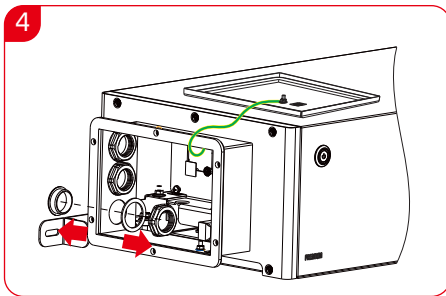
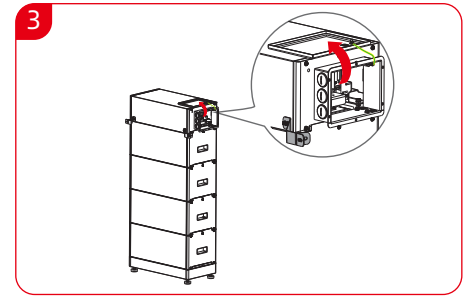
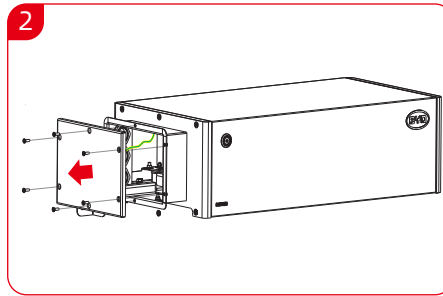
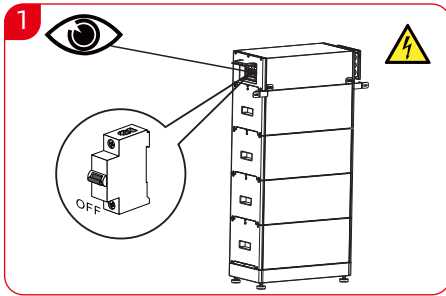

9. Connecting the Data Cable to other Battery System(s)

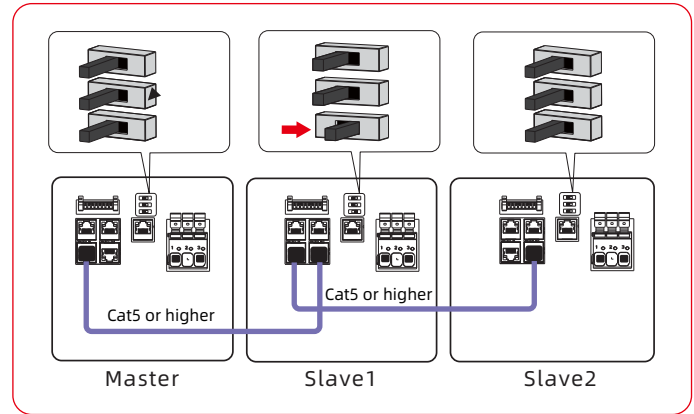
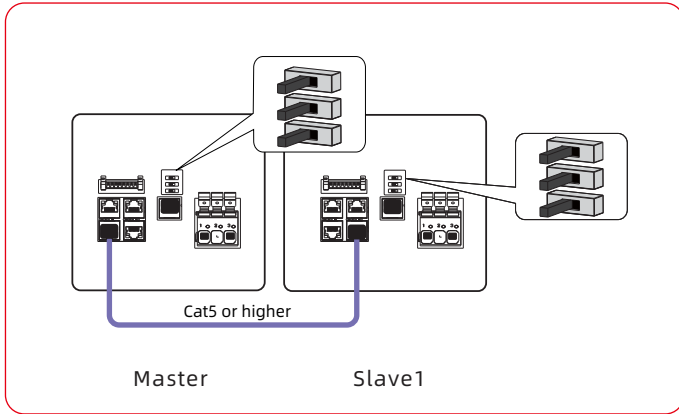

10. Data Cable Connection to Inverter

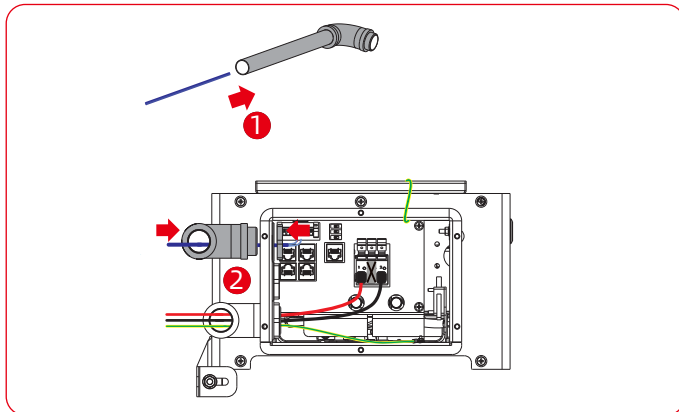

11. Connecting the Network

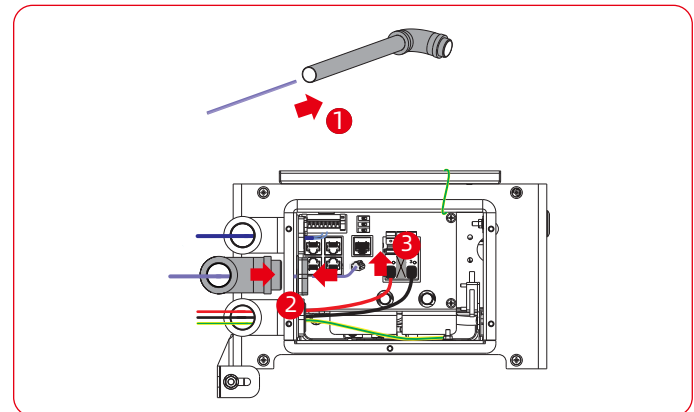

12. Close up

NOTICE

If the panel is not closed, the battery cannot be turned on.

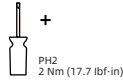
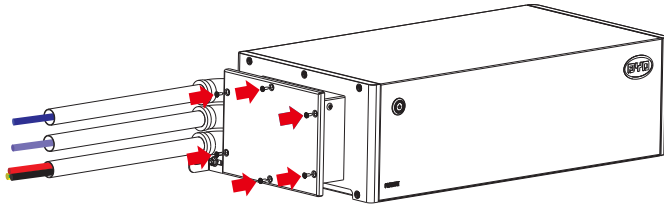

13. Commissioning

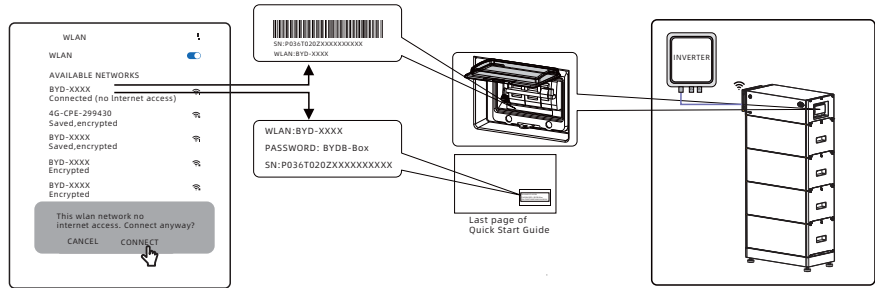
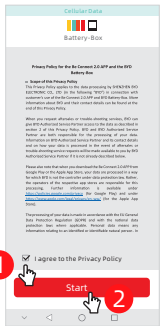

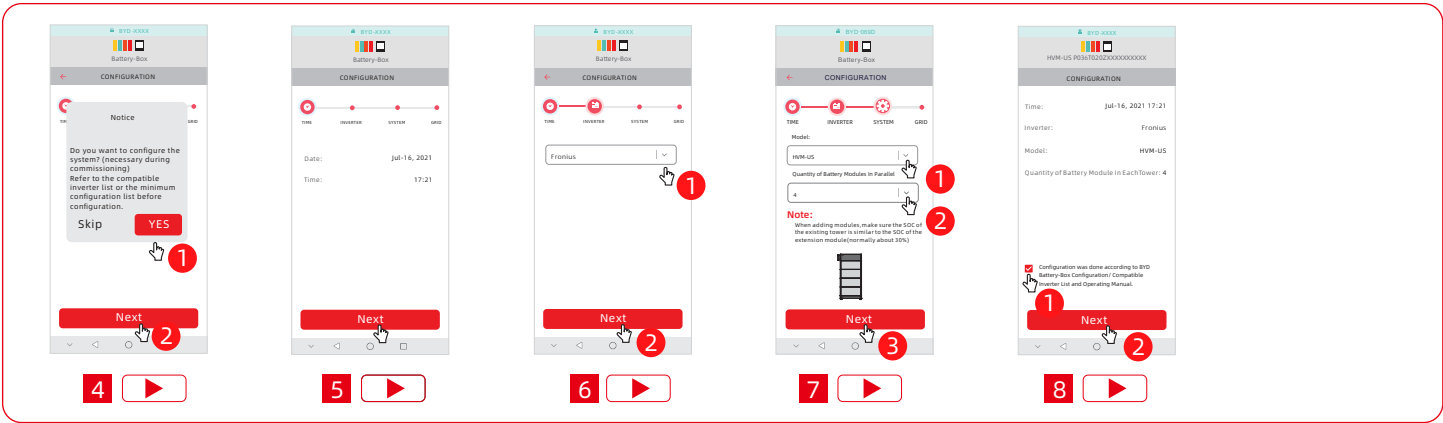

14. Switch ON/OFF Procedure

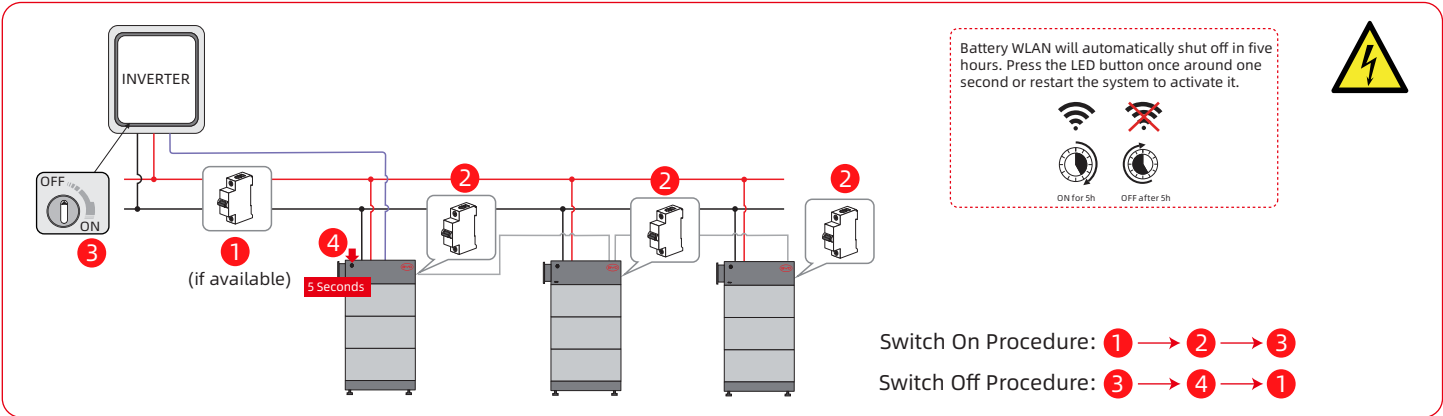

15. Extension

Note: Within 5 days before extension, it is recommended to fully charge the original system to SOC 100% at least once.

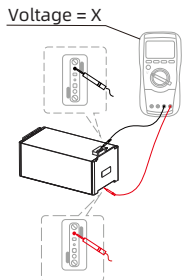

- ① Measure the voltage of the new battery module, get a value (X).

	Voltage (X)/ V	SOC(Y)
HVM-US	<50.4	0~5%
	50.4≤V<51.52	5~10%
	51.52≤V<51.84	10~15%
	51.84≤V<52.32	15~20%
	52.32≤V<52.672	20~25%
	52.672≤V<52.848	25~30%

- ② Refer to the above table to find out the SOC (Y) corresponding to the X.

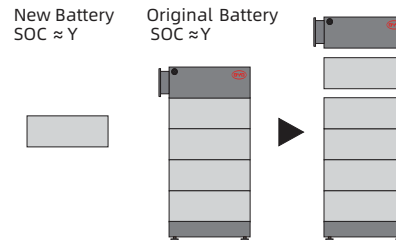

- ③ Charge or discharge the original battery system until the SOC is almost equal to Y, and then add the new battery module. Do not forget to do the configuration after that.

16. LED Status

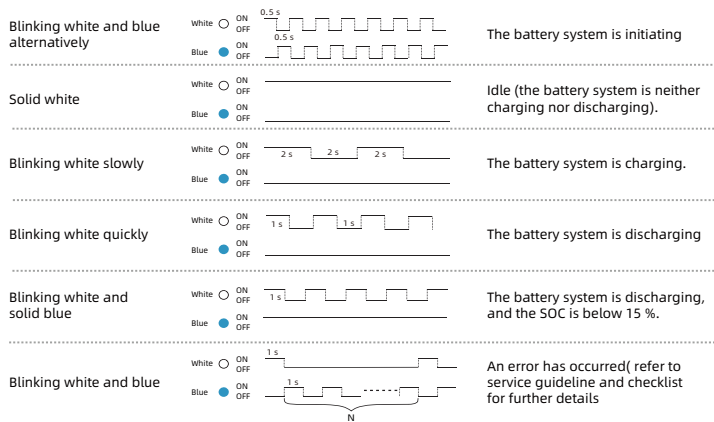

Communication Options with Inverters

CAN Port

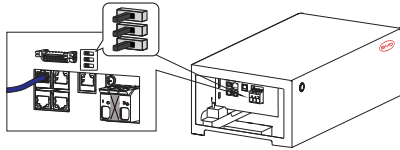

PIN	1	2	3	4
CAN/ B-Pin	CAN H	CAN L	EN_GND	EN

8-pin Connector

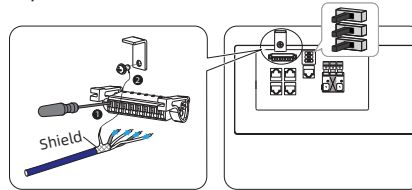

1 Fronius Primo Gen24 Plus/ Symo Gen24 Plus option a

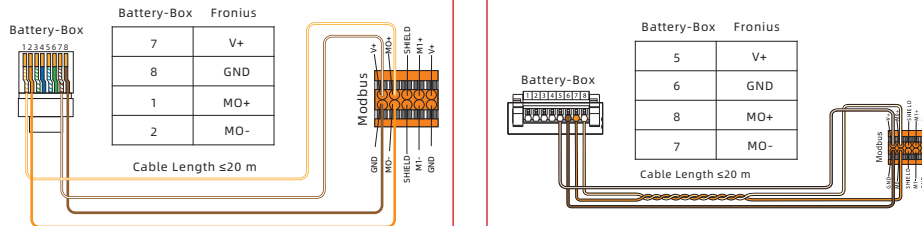

2 Fronius Primo Gen24 Plus/ Symo Gen24 Plus option b

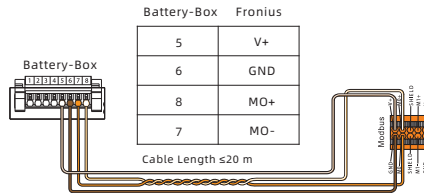

WLAN name, password and serial number.

BYD Global Service

✉ bboxservice@byd.com

☎ + 86 755 89888888-47175

📍 No. 3009, BYD Road, Pingshan, Shenzhen, 5118118, P.R. China

🌐 www.bydbatterybox.com

US Service BYD AMERICA LLC

✉ us.homeenergy@byd.com

☎ 626-491-2333

📍 888 E Walnut, St. Suite 200A, Pasadena, CA 91101, USA

🌐 www.bydbatterybox.com



17359105-00